

QUICK  **LOCK**
BIG



Quick-Lock BIG

User Manual

UHRIG

Kanaltechnik



Uhrig Kanaltechnik GmbH
Am Roten Kreuz 2
78187 Geisingen

Telefon +49 7704 / 806-0
Web www.uhrig-bau.de
E-mail info@uhrig-bau.de

1. About this document	4
1.1. Regulations	4
1.2. Certifications	4
2. Description of the Quick Lock BIG system	5
2.1. Intended use	5
2.2. Components and functions	6
2.3. Description of the system and procedure	6
2.4. Suitability and materials used	6
3. How to use the system	7
3.1. Preparation	7
3.1.1. Inspecting the pipe	7
3.1.2. Preparing the damaged area	7
3.2. Equipment and materials	8
3.3. Installing Quick-Lock BIG	10
3.4. Serial installation	16
3.5. Tool maintenance	17
4. Appendix 1 Technical data sheet	18

1. About this document

These instructions supplement the basic Quick-Lock user manual. They specifically describe how to use the Quick-Lock BIG system. Please observe the aforementioned user manual with its general instructions on using the Quick-Lock system.

1.1. Regulations

See the main Quick-Lock user manual.

1.2. Certifications

The Quick-Lock BIG System is not certified under building law.

2.1. Intended use

The Quick-Lock BIG sleeve is a product for permanently and tightly sealing leaking pipe joints, radial cracks and longitudinal cracks in large pipes and manholes of DN 800 and larger.

- The sleeve is 20 cm wide
- The sealed area (between the circumferential seals) is approximately 12 cm.
(The distance between the circumferential seals is approximately 14 cm. However, these are pulled together when the jacket is expanded so that the sealed area is 12 cm wide.)

The system is made from V4A stainless steel of grade 1.4404 (AISI 316L) and an EPDM compression seal.

- The materials used are permanently resistant in municipal wastewater systems.
- Their suitability must be ascertained for use in industrial or polluted wastewater.

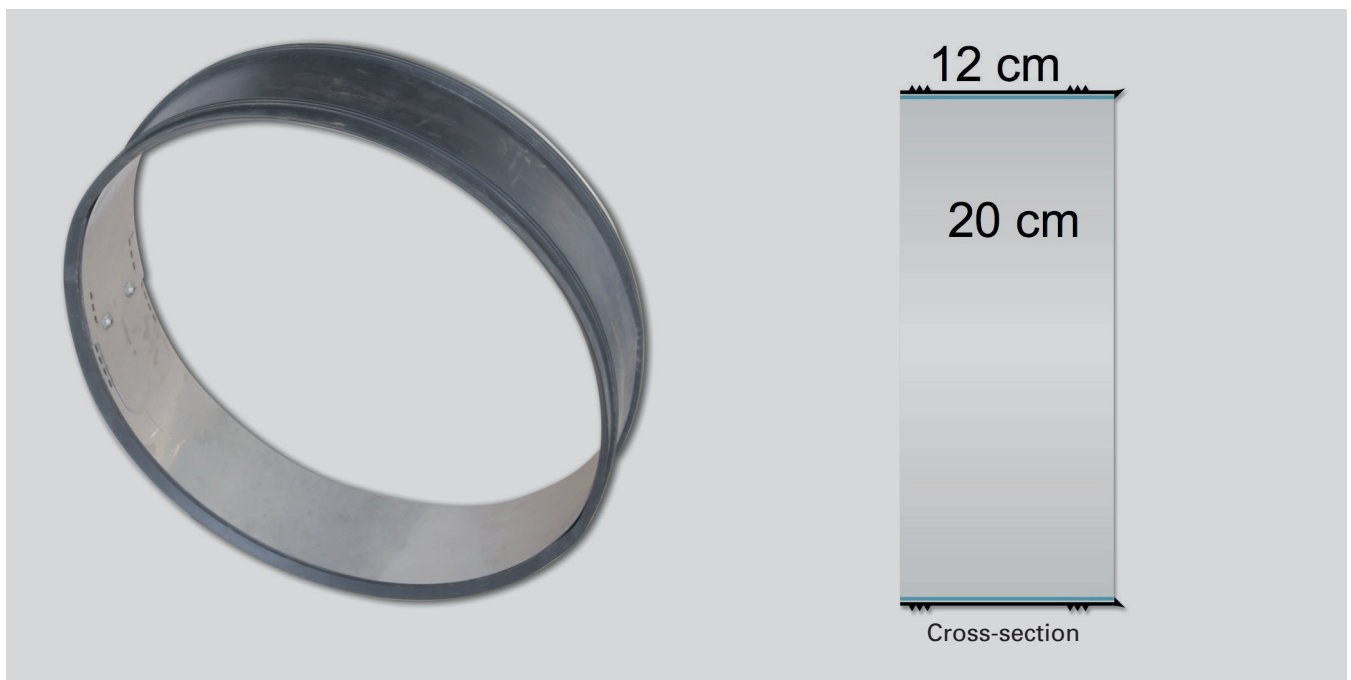

2.2. Components and functions

System components

- Stainless steel sleeve consisting of two or more sections
- Locking screws (4x)
- Sliding blocks (4x)
- Rubber jacket (1x)



2.3. Description of the system and procedure

See the main user manual.

2.4. Suitability and materials used

See the main user manual.

3. How to use the system

3.1. Preparation

3.1.1. Inspecting the pipe

Before using Quick-Lock BIG, the pipe must be inspected to ascertain whether it can be repaired with the system.

See the main user manual.

3.1.2. Preparing the damaged area

Before installing the Quick-Lock BIG sleeve, the damaged area must be prepared as follows:

- Manually remove all protruding obstacles (seals, roots)
- Manually even out any joint misalignments of more than 0.5 cm using special mortar. In some circumstances, using epoxy resin for reprofiling may only be possible when the concrete is wet, but not soaked through. Generally, we do not recommend it.

Recommended mineral mortars:

- Sealt-Tec P
- Ergelit S100
- Ombran MHP 15

Flowing water (infiltration) always poses problems.

- Therefore, stop the infiltration in advance using plugging mortar.
- Even out any corroded, porous inner pipe surfaces in the area to be sealed using special mortar.

3.2. Equipment and materials

Installation tools

(Supplied by Uhrig)

- Four clamping tool sections
 - 2 x with screw unit
 - 2 x with seat
- (1) Spindle
 - For pre-tensioning the sleeve
- (2) Clamping screws
 - For clamping the sleeve and pressing it in place

- (3) Retaining lug
 - For attaching the tool to the sleeve

Depending on the pipe diameter, the retaining lugs (3) on the installation tool may have to be changed. These parts are supplied with the tools.

The retaining lugs must be mounted as illustrated (3).

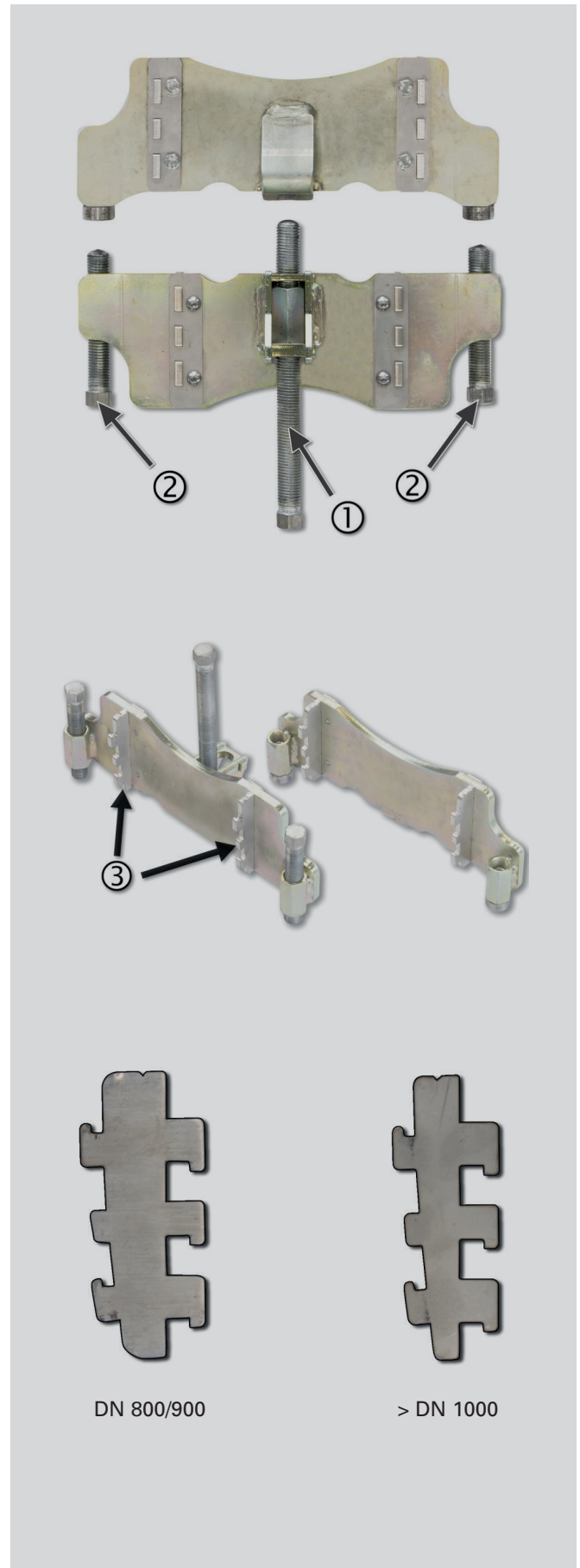

Required accessories

Make sure you have the necessary tools.

If necessary we can provide the tools for sale or hire.

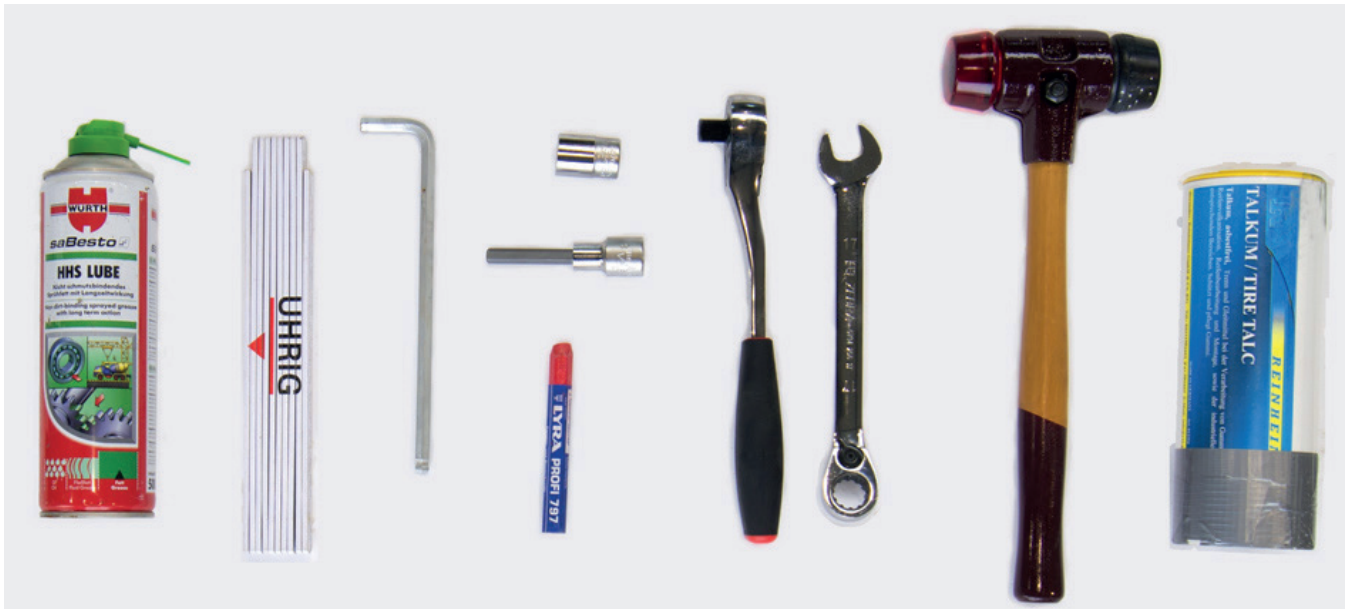

- Lubricant
- Ruler or tape measure
- 8 mm Allen key
- 17 mm socket
- Crayon
- Interchangeable socket wrench (or 17 mm ratchet spanner)
- Plastic or rubber mallet
- Talcum powder
- Laser for measuring the damaged area (optional, not shown)
- Pneumatic socket wrench (optional for rapid installation)



3.3. Installing Quick-Lock BIG

Installation

Bringing in the sleeve

- Do not assemble the sleeve.
- Bring in the sleeve via the manhole entrance.

Putting the sleeve together

- Join the sleeve sections together so that the tracks punched out of them are on the outside.
- Place the sliding blocks in the tracks.
- Secure the sliding blocks with the locking screws.

- Adjust the sleeve to the smallest diameter and tighten the locking screws.

Applying talcum powder to the rubber jacket

- Apply talcum powder to the inside of the rubber jacket.



Preassembling the sleeve

- Pull the jacket over the sleeve until the tapered rubber edge lies on the steel sleeve.
- The preassembled sleeve is rolled so tightly that it can be taken into the pipe and turned around there.



Marking out the position

- On one side of the damage, at a distance of 10 cm from the centre (the sleeve length is 20cm), mark out the position of the sleeve all the way around the circumference of the pipe.

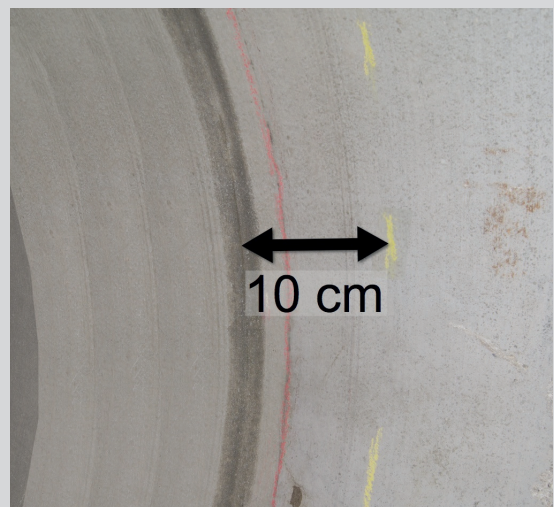

Positioning the sleeve

- Position the sleeve so that the tapered edge of the rubber faces against the direction of flow.

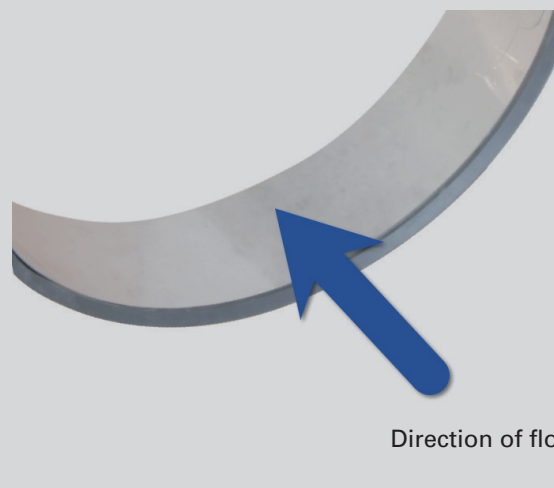

Aligning the sleeve

- Align the sleeve to the marking in the pipe.
- Turn the sleeve so that the locking screws are roughly level on the left and right sides of the pipe.
- The sleeve must always be installed perpendicular to the axis of the pipe. When using a spirit level, the pipe slope must be adjustable.



Attaching and securing the clamping tools

- The clamping tools on the left and right sides are identical.
- However, the clamping tools are aligned differently on the left and right: one of them points up and the other points down.
- Attach the two parts of each clamping tool as close together as possible.
- Tighten the spindles to hold the clamping tools in place.

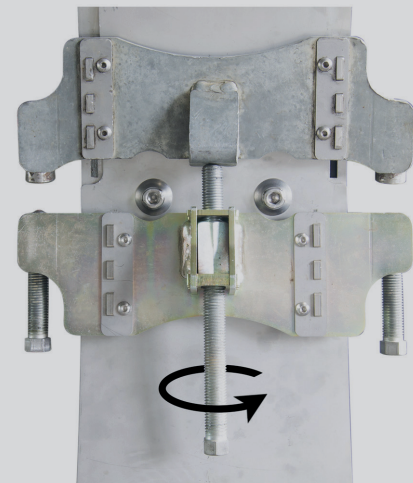

Expanding the sleeve

- Start on one side.
 - Loosen the locking screws.
 - Tighten the spindle to about half way until the sleeve is pressed against the pipe.
 - When expanding the sleeve, make sure it opens up evenly. The easiest way to do this is to look at the holes on the left (1) and right (2).
- Continue on the other side:
 - Loosen the locking screws here too.
 - Tighten the spindle to about half way.

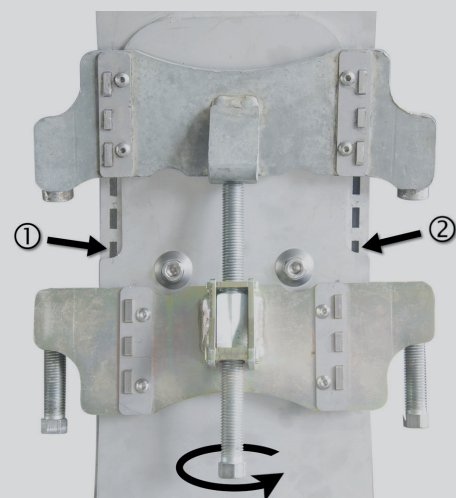

Aligning to the marking

- Just before the sleeve is pressed to the pipe, align it once again to the marking or the axis of the pipe.

Repositioning the clamping tools

- Tighten the locking screws.
- Loosen the spindles.
- Reposition the two parts of each clamping tool as close together as possible.
- Fasten them with the clamping screws.

Clamping

- Keep working on both sides of the sleeve alternately:
 - Loosen the locking screw.
 - Tighten the two clamping screws evenly. Use the holes as a guide.

Tapping in

- While you are doing this, occasionally tap all the way round the sleeve with the mallet so that the tension is evenly distributed.

Note

The spindle is only designed for expanding the sleeve. The sleeve is clamped using the two clamping screws on the left and right of the tool.

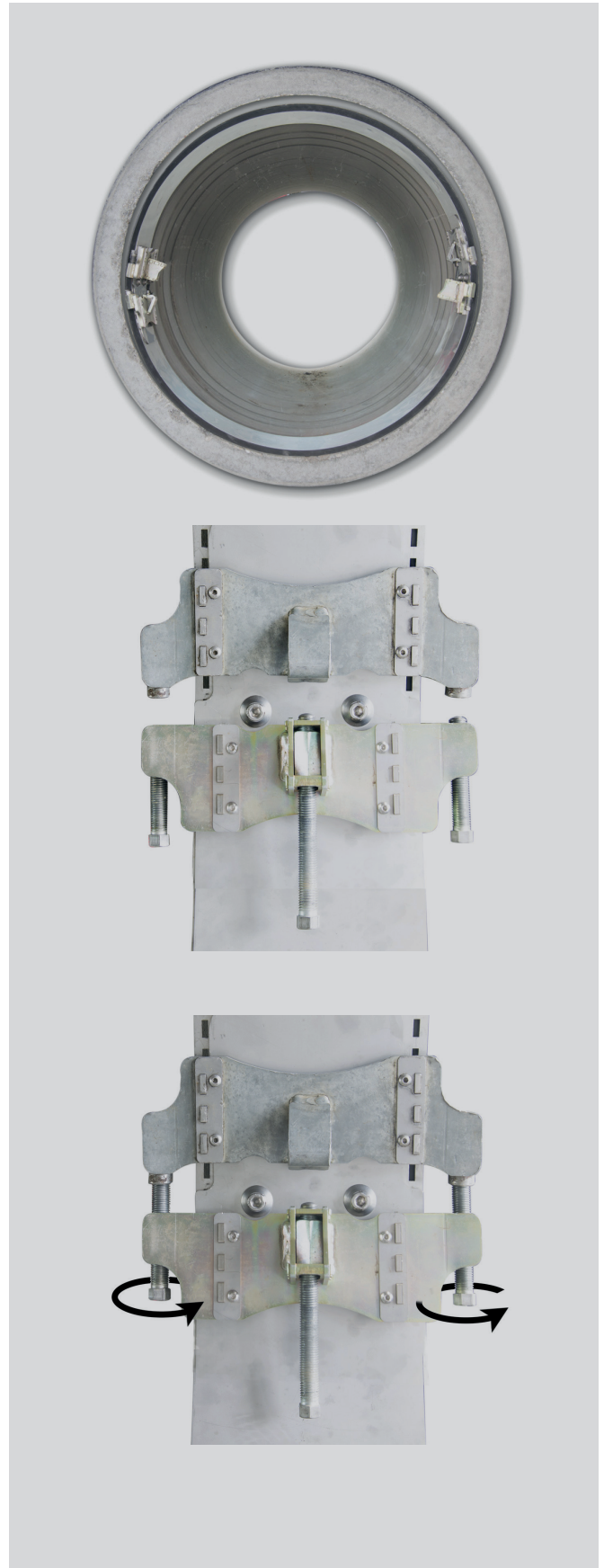

Compressing to 12 mm / 13 mm

- Keep clamping until the added material (rubber jacket + metal) is less than
 - 12 mm for DN 800 – DN 1300
 - 13 mm for more than DN 1300
- Measure all the way round (< 12 mm/13 mm).



Eccentric expansion (if necessary)

- For minor joint misalignments, bends or persisting leaks, the sleeve can be expanded eccentrically using the second clamping screw. Note: If the sleeve is expanded too eccentrically, the tools can become jammed.
- Use the holes as a guide.

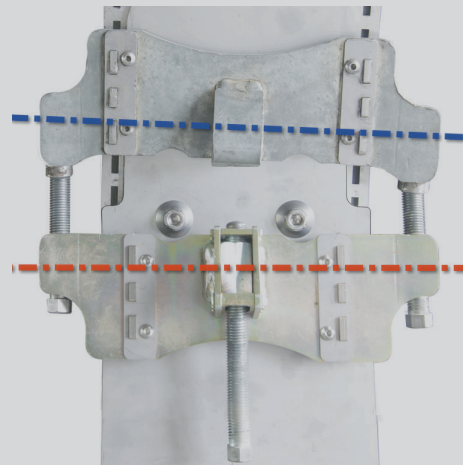

Tightening the locking screws

- Make sure that the sleeve has reached its final state.
- Tighten the locking screws using the ratchet.

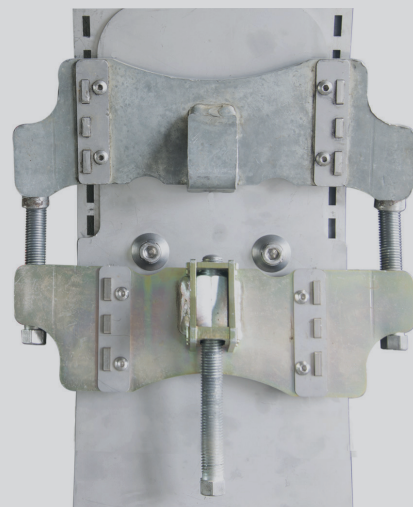

Removing the clamping tools

- Loosen the clamping screws of the tools.
- Remove the tools.



- The Quick-Lock BIG sleeve now forms a tight and reliable seal.

3.4. Serial installation

For longer areas of damage, serial installation is sometimes possible.

- We can supply a 25 cm wide rubber overlap, with each half between the actual seal and the pipe wall.
- The distance between the sleeves should be at least 40mm in order to leave enough space for the clamping tools.
- When two BIG sleeves are installed in series, the tapered rubber edge on each one faces outwards.
- If more than two sleeves are installed in series, the tapered rubber edge must be trimmed off on the middle ones.

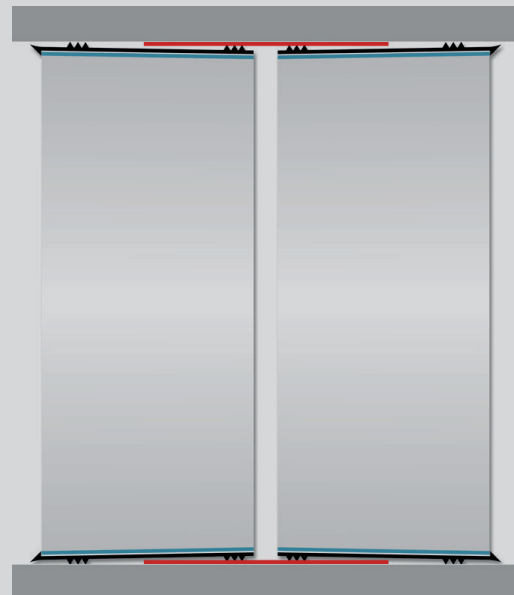
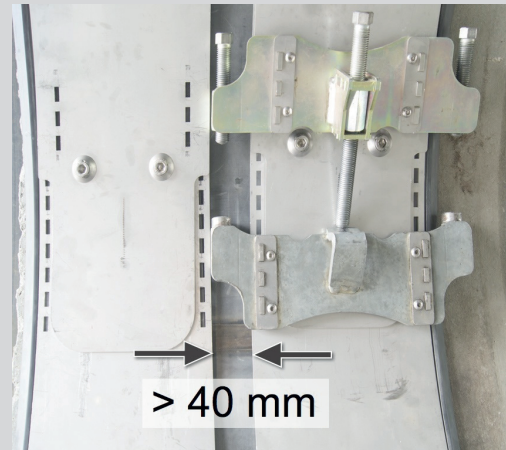

3.5. Tool maintenance

Maintenance

- The spindles and clamping screws must be treated with high-pressure lubricant (Metaflux lubricating metal) after each use.
- Damaged retaining lugs can be replaced with the aid of the two socket screws.

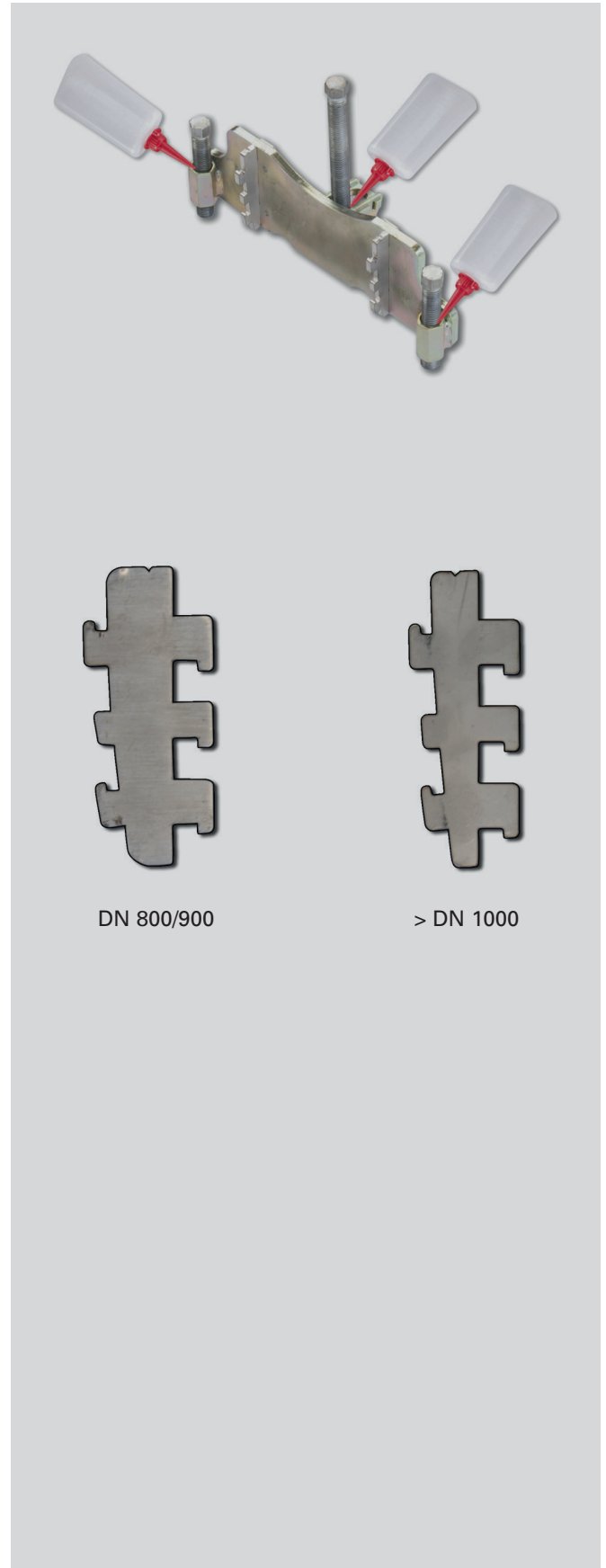

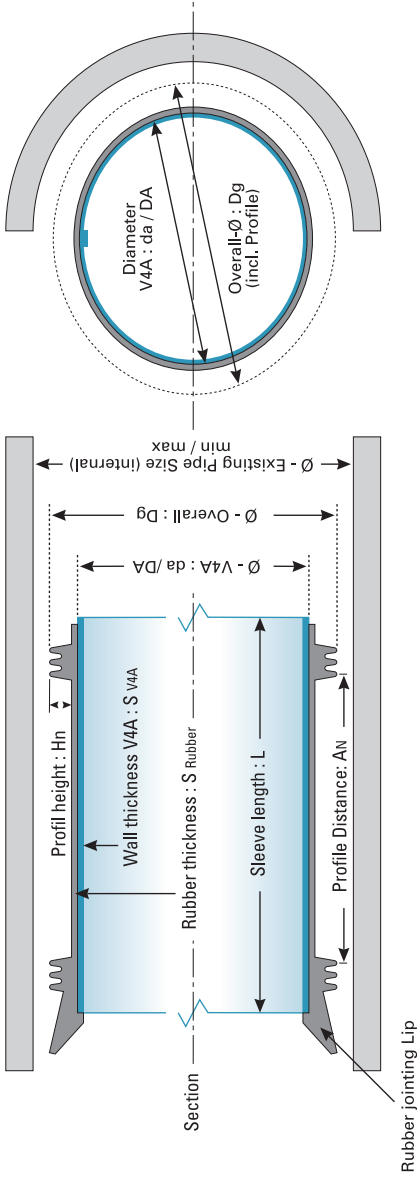

Quick-Lock BIG sleeve DN	x parts	Sleeve length	Total diameter, rolled	Suitable for pipes from / to		Stainless steel sleeve			Rubber jacket		
				Pipe ID min.	Pipe ID max.	Wall thickness	V4A pipe rolled	Max. expanded diameter	Rubber thickness	Height of seals	Distance between seals
mm	inch	mm	mm	mm	mm	mm	mm	mm	mm	mm	mm
800	32"	200	738	770	830	3	710	815	3	11	140
900	36"	200	838	870	930	3	810	915	3	11	140
1000	40"	200	938	970	1030	3	910	1015	3	11	140
1100	44"	200	1038	1070	1130	3	1010	1115	3	11	140
1200	48"	200	1138	1170	1230	3	1110	1215	3	11	140
1300	52"	200	1238	1270	1330	3	1210	1315	3	11	140
1400	56"	200	1338	1370	1430	4	1310	1415	3	11	140
1500	60"	200	1438	1470	1530	4	1410	1515	3	11	140
1600	64"	200	1538	1570	1630	4	1510	1615	3	11	140
1700	68"	200	1638	1670	1730	4	1610	1715	3	11	140
1800	72"	200	1738	1770	1830	4	1710	1815	3	11	140
1900	76"	200	1810	1870	1930	4	1810	1915	3	11	140
2000	80"	200	1910	1970	2030	4	1910	2015	3	11	140